



UNIVERSITY OF  
Nebraska  
Lincoln

**EXTENSION**

4H167



Extension is a Division of the Institute of Agriculture and Natural Resources at the University of Nebraska–Lincoln cooperating with the Counties and the United States Department of Agriculture.

The 4-H Youth Development program abides with the nondiscrimination policies of the University of Nebraska–Lincoln and the United States Department of Agriculture.

revised 3/08

# Sewing For Fun

## Project Planning and Evaluation Sheet

Name \_\_\_\_\_ 4-H age \_\_\_\_\_ Year \_\_\_\_\_

Years in 4-H \_\_\_\_\_ Name of club \_\_\_\_\_

Signature of leader or parent \_\_\_\_\_

**I plan to do  
these activities:**

**From this activity  
I learned:**

**Comments:**

1		
2		
3		
4		
5		
6		

**Presentations or community service activities** \_\_\_\_\_

\_\_\_\_\_

\_\_\_\_\_

\_\_\_\_\_

# Sewing for Fun

## What You'll Do In This Project

Learning how to sew is a skill. A skill is being able to do something well. The more you practice a skill, the better and easier it becomes. Dancers, artists, chefs and athletes become skilled through many hours of practice. As a beginning sewer you also will need to practice so you can become skilled at sewing.

Learning how to sew is interesting and fun! In this project you will learn beginning sewing skills. You will:

- Choose and use sewing equipment.
- Use and care for a sewing machine.
- Sew straight and curved seams and square corners.
- Use a needle and thread.
- Know differences between woven, knit and felt fabric.
- Define sewing and fabric terms.
- Measure accurately.
- Read and follow directions.
- Select fabric and sewing notions for projects.
- Keep 4-H records using the Home Economics Project Planning and Record Form.

Your first sewing efforts won't be perfect. Don't worry about this. You need to learn to enjoy sewing and feel good about finishing several items. Don't try making one "perfect" item. Remember, practice makes perfect! Practice, practice, practice.

You can tell or show others what you have learned in your project, give a presentation or exhibit at the fair.

Use this manual to guide you as you learn to sew. It will tell you about the tools you need and show you how to begin using the sewing machine. It has information about fabric that you should learn before you start to make an item. The section on hand sewing will help you use a needle and thread.

You can learn lots of new ideas when you sew. Have fun making things for yourself and others! Again, remember, practice makes perfect.

## Acknowledgments

The contents of this bulletin have been adapted from the 4-H Sewing For Fun I, produced by Washington State University, Dr. Dorothy Ettl, Extension Textiles and Clothing Specialist.

Original text additions and changes by Rose Marie Tondl, Extension Clothing Specialist; revisions by Sarah Effken Purcell, Extension Educator, University of Nebraska–Lincoln.

Cover design by Renee Lanik, layout by Anne Moore, University of Nebraska–Lincoln.

To purchase copies of this or other Nebraska 4-H publications, please call (402) 472-9713 or e-mail [4hcurriculum2@unl.edu](mailto:4hcurriculum2@unl.edu)

## Project Requirements

A 4-H Sewing Skills Check List is in the back of this manual. To complete Sewing for Fun, you should:

- Be able to check off 40 of the 52 skills listed.
- Over two or three years, make at least six or seven of the listed items for yourself or others using those skills.

Plan the things you want to make. Begin with something simple. The more items you make, the more you will learn. Choose from the list below using the directions in the "Sewing for Fun" packet for county fair entries.

Pin cushion  
Needle book  
Pillow case  
Laundry bag  
Tote bag

Three-striped pillow  
Diagonal pillow  
Patchwork pillow  
Rail fence pillow

You may use your own ideas. Family magazines and pattern books have ideas for items you can make. Your leader also may have some suggestions. You should take this project for two or three years, depending on how well you develop your sewing skills.

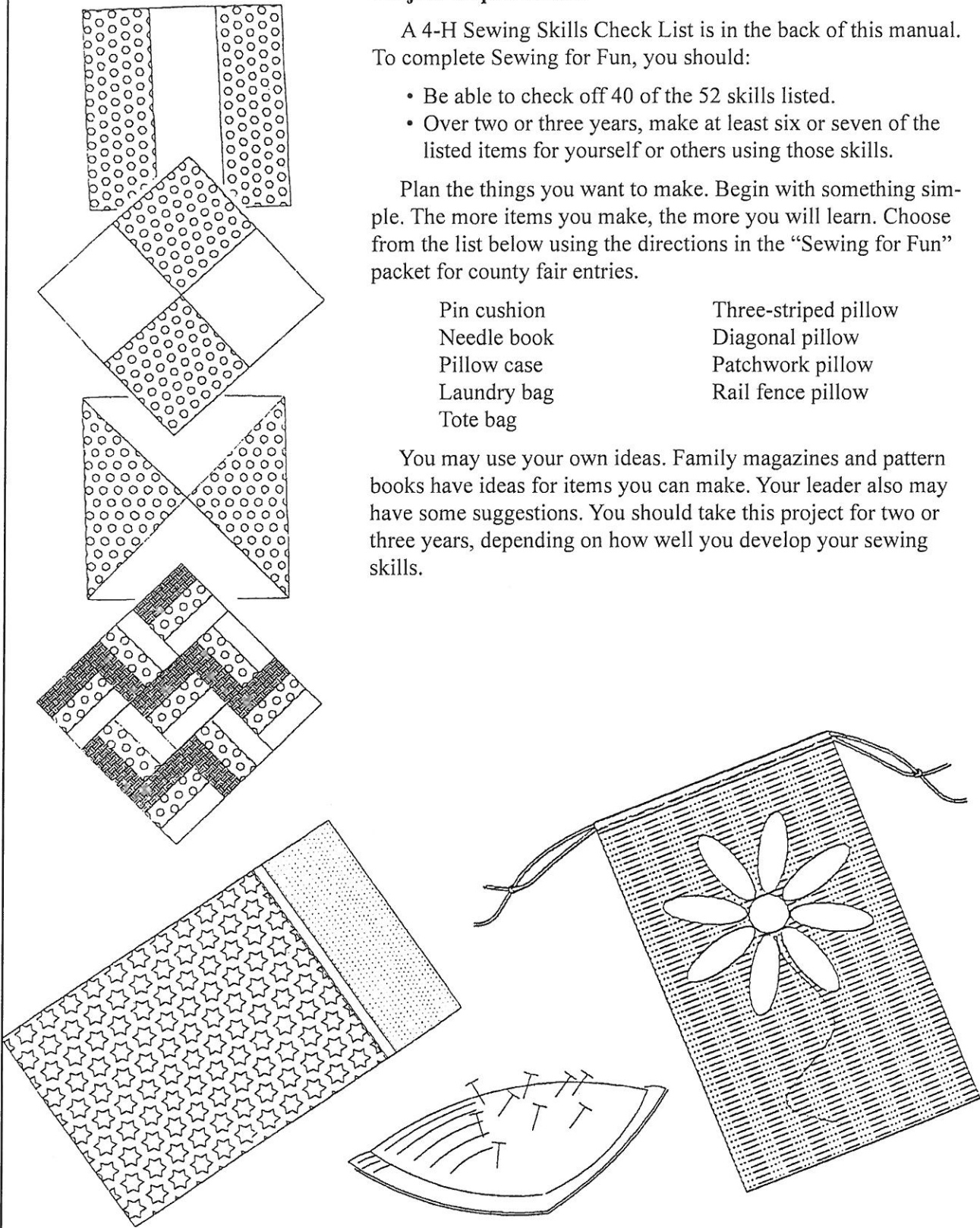

## Sewing Tools

You need good tools to do good work. You will need tools for measuring, cutting and sewing. Keep your tools in a sewing basket or decorate a strong cardboard box for your things.

You will need to have or be able to borrow these tools:

### Cutting Tools

**SHEARS** — They are for cutting fabric, not paper. Be sure they are sharp. A 7-inch length is easy to handle. Shears have a small ring handle for thumb and a large loop handle for several fingers.

**SCISSORS** — They are used for snipping threads, cutting corners and trimming seams. Scissors are less than 6 inches long and have two ring handles the same size.

**SEAM RIPPER** — This tool is used to clip threads when removing machine stitches.

### Measuring Tools

**TAPE MEASURE** — Plastic-coated, 60-inch ones are best. Check to see that it is numbered on both sides with the numbering running in opposite directions.

**SEAM GAUGE** — A short ruler is helpful for making and checking widths of seams and hems. One that is 6 inches long is a good size.

### Small Sewing Equipment

**PINS** — Fine, sharp pins are best. These are often called silk pins. Colored ball heads may be easiest for you to work with.

**PINCUSHION** — This is a small, filled cushion used to store your pins.

**NEEDLES** — These come in many types and sizes. The needle should be small enough to slip through the fabric easily. Crewel needles have long, slender eyes for easier threading. A size 7 or 8 will be best while you are learning to sew.

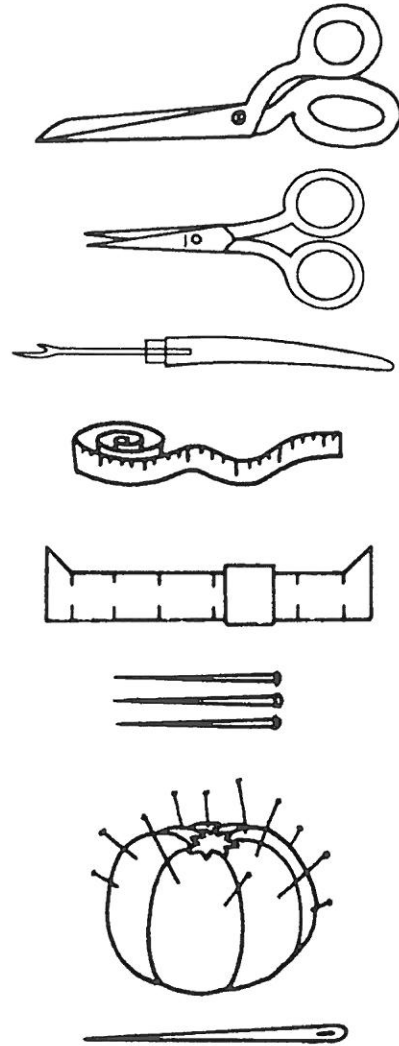

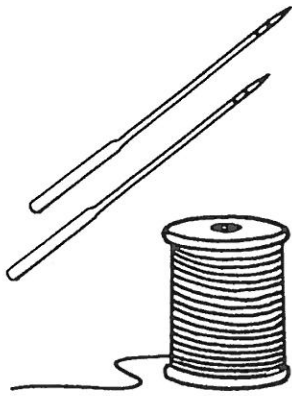

**SEWING MACHINE NEEDLES** — These needles come in fine, medium and coarse. The size of needle you use depends on the weight of the fabric you will be sewing. The bigger the number, the bigger the needle. A size 14 (European size 90) is best for medium-weight fabric.

**THREAD** — Select a cotton polyester or long, staple polyester thread. Match the thread to your fabric. Select a thread that appears to be slightly darker than the fabric. When sewn into the fabric, it will appear lighter than it does on the spool.

**GLUE STICK** — A type of washable solid adhesive used instead of pinning and basting fabric together, positioning trim, etc.

**POINT TURNER** — A flat tool with a pointed end for pushing out corners, points and curves.

**THIMBLE** — A cover for the middle finger to protect it when you push the needle through the fabric.

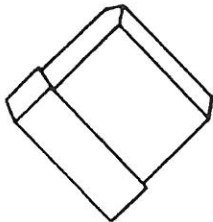
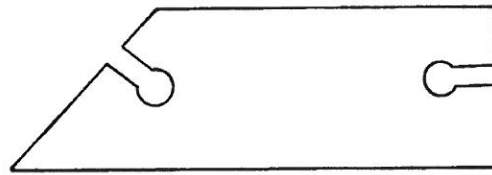
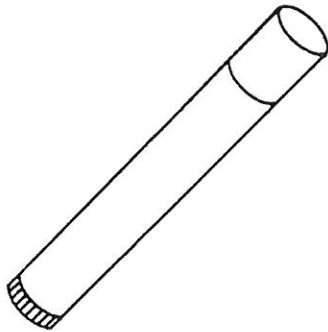

### Marking Tools

**TAILOR'S CHALK** — Available in pencil form or rectangular shape.

**MARKING PENS** — Two types are available — water soluble and air-erasable.

**SOAP** — Use slivers of oil-free bar soap.

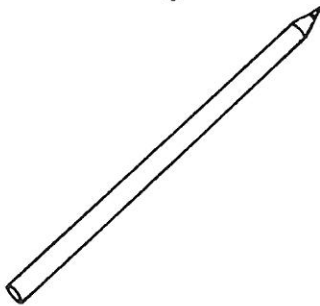

### Pressing Equipment

**IRON** — Use a steam-dry iron. Read and become familiar with the different fabric settings on the iron.

**IRONING BOARD** — You will need an ironing board placed close by the sewing machine for handy use. Adjust the ironing board to a comfortable height for you.

**Do Sewing Tools Crossword Puzzle in the back of this manual.**

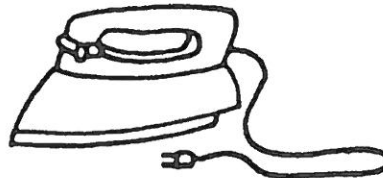
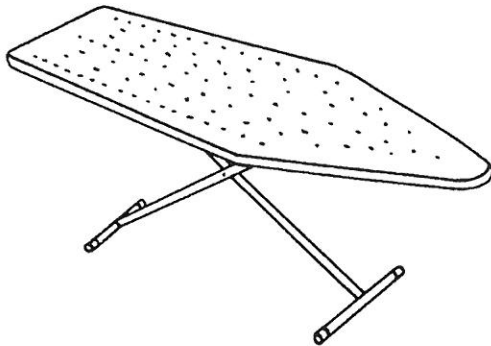

## Start Sewing With Good Habits

Start practicing good work habits when you use the sewing machine. This will help make your sewing easier and faster.

- Work in good light.
- Sew with clean hands and smooth, clean nails.
- Use a wastebasket for your threads and scraps.
- Practice good posture when using the sewing machine. Sit tall when you sew; don't lean on the machine for support.
- Have your iron and ironing board nearby.
- Put your tools and fabric away when you are finished.

## The Sewing Machine

All sewing machines have the same basic stitching parts even though they don't look the same. The instruction book that came with the machine will tell about its parts. Look at this list of parts and the drawings on page 8 to see where the parts are. Try to find the same parts on the sewing machine you use.

Here are the names and uses of the machine parts you will need to know:

1. SPOOL PIN — Holds the thread that makes the top part of the seam. The thread guides hold the thread in place.
2. THREAD-TAKE-UP LEVER — Moves up and down pulling the thread to the needle. Be sure it is at its highest level before beginning to sew. If it's not, your needle may come unthreaded.
3. THREAD TENSION DISCS — These make the needle thread tighter or looser. If it is just right, stitches will be smoother and even.
4. PRESSER FOOT-LIFTER — This is a lever found in the back of the machine. It raises or lowers the presser foot.
5. PRESSER FOOT — Holds the fabric while the needle passes between the toes.
6. NEEDLE — The eye is near the point for holding the thread. It draws the thread through the fabric and back again to make stitches.
7. FEED DOG — A set of small metal teeth that moves the fabric as you sew.
8. BOBBIN — A small round metal or plastic object that holds the thread for the bottom half of the stitches.
9. BOBBIN WINDER — Winds the thread onto the bobbin.
10. THROAT PLATE — A metal plate usually with guidelines to help you sew straight.
11. STITCH REGULATOR/REVERSE STITCH LEVER — This lever makes stitches longer or shorter, and on some models makes your machine sew backwards.
12. HAND WHEEL — It raises or lowers the needle and moves the take-up lever up and down.

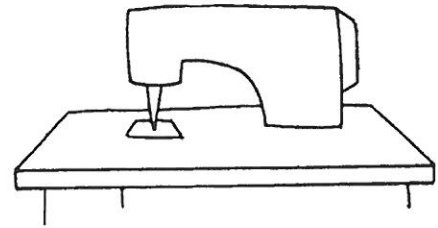

**Do Sewing Machine Parts Crossword Puzzle in the back of this manual.**

# Parts of a Sewing Machine

## 1. SPOOL PIN

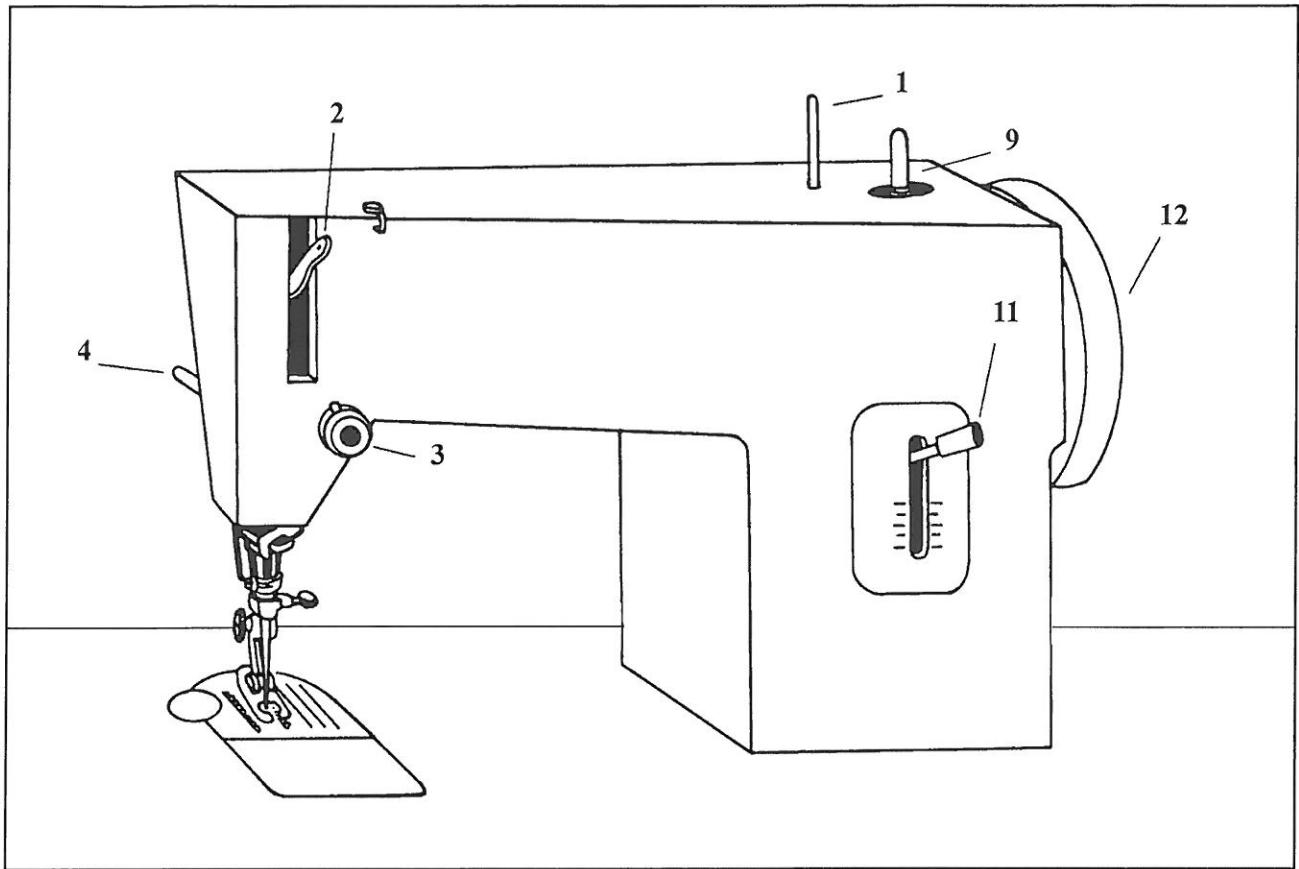

- 2. THREAD-TAKE-UP LEVER
- 3. THREAD TENSION DISCS
- 4. PRESSER FOOT-LIFTER
- 5. PRESSER FOOT
- 6. NEEDLE
- 7. FEED DOG
- 8. BOBBIN
- 9. BOBBIN WINDER
- 10. THROAT PLATE
- 11. STITCH REGULATOR/  
REVERSE STITCH LEVER
- 12. HAND WHEEL

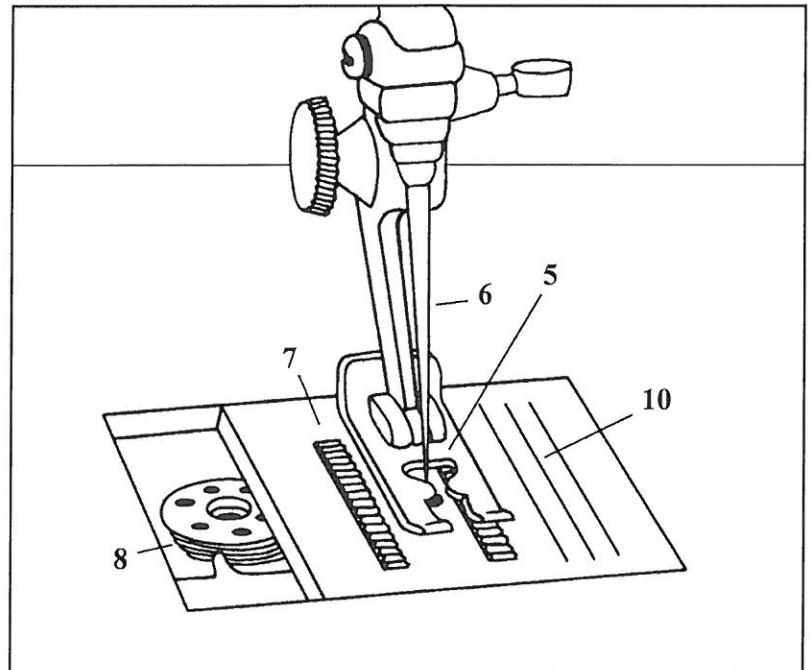



## Care of the Sewing Machine

Keep your sewing machine clean. Remove lint often. Wipe the upper parts of the machine with a soft cloth. Use a lint brush to clean the bobbin area and other hard-to-reach parts. Look in your sewing machine instruction book for a list of places that need oiling. Ask your 4-H leader or an adult in your family to help you add a drop of sewing machine oil to the moving parts.

Clean the machine often so it will run in top condition.

## Using The Sewing Machine

Be careful when using the machine. It is an expensive item. Here are some rules to follow so you won't get hurt:

- Keep your foot/knee away from the foot/knee control except when actually sewing.
- Keep fingers away from the needle.
- Run the machine slowly and evenly.
- Do not tease another person who is sewing.
- Think about what you are doing when sewing.

## Sewing Without Thread

Begin by running the machine without a needle and with the presser foot up. Ask your 4-H leader or other adult how to remove the needle. Try different sewing speeds. Learn to start and stop smoothly.

The next step is to practice with a needle, but without any thread.

Put the needle back into the machine. Check the instruction book for the correct way. Practice sewing on lined paper or draw your own designs. There are stitching charts in the back of this manual that you can copy.

Lower the needle into the lined paper by turning the hand wheel toward you. Lower the presser foot. Guide the paper gently with both hands as you stitch. Don't push or pull. See how straight you can make your lines. Stop with needle in its highest position. The take-up lever also will be at its highest position. Also try some curves. You may want to practice this several times. Practice, practice, practice!

Practice changing the stitch regulator to different stitch lengths. Stitch on different lines by setting the stitch regulator at different stitches per inch. A regular stitch length is 10-12 stitches per inch. It is called a regulation stitch.

You also can do basting stitches on the machine. These are long stitches. Set the machine at six to eight stitches per inch. Make samples of the different stitch lengths on paper.

### Turning Square Corners (or Pivot)

Draw a 6-inch square on paper. Inside of it draw a 5-inch square and then a 4-inch square. Start with the 6-inch square:

1. Sew up to the corner.
2. Stop stitching at the corner with needle in the paper.
3. Raise the presser foot.
4. Turn/pivot the paper to continue following the line.
5. Lower the presser foot.
6. Stitch to the next corner.
7. Repeat the steps.

Practice turning corners on all three squares. Pat yourself on the back if you stayed on the lines!

Before you sew on fabric, change the sewing machine needle. Sewing on paper will dull it. The needle must be sharp to go through the fabric without pulling any threads.

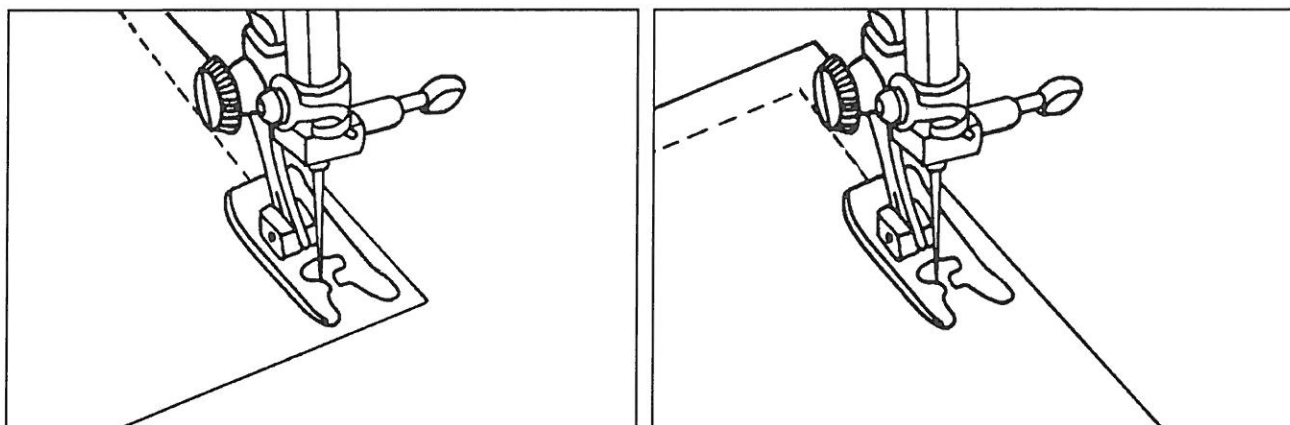

### Sewing With Thread

A family member or leader will show you how to thread the machine, wind the bobbin and put the bobbin in place for sewing. Study the instruction book for threading your own machine. Watch carefully so you will be able to thread the machine. Practice several times until you can do it by yourself.

Practice sewing on two strips of fabric to see how straight and even you can stitch. Stitch slowly so you have good control of the machine.

The throat plate is marked off in 1/8 inch sections with the numbers 3-4-5-6. The number 4 means 4/8 inch or 1/2 inch. The number 5 means 5/8 inch. If there are no markings on your machine, make your own. Put a strip of tape 5/8 inch from the needle hole. Use this as a guide for stitching. You also can use an attachable seam guide if it comes with your machine. Set the stitch regulator at 10-12 stitches per inch. Practice sewing a 5/8-inch seam. Lower the needle into the cloth 1/2 inch from the beginning of the seam; lower the presser foot. While holding the two threads,

backstitch to the beginning of the seam. Continue to sew to the other end of the seam. Backstitch a few stitches to lock the end. To sew straight, watch the edge of the presser foot or the seam guide. Do not watch the needle as you sew.

Stop with the needle at its highest point. Lift the presser foot and gently pull the fabric to the back and to the left.

Clip the threads.

Check the stitching you have done.

If it puckers, it is too tight. If it is too loose, there will be spaces between the two layers of fabric when you spread them apart. If this happens to you, the tension on the machine needs adjusting. Ask someone in your family to help you adjust the tension.

Practice sewing straight seams, curved seams and turning corners. Practice sewing with regular and long stitches. Try out some of the zigzag or pattern stitches if your machine has them.

Don't worry if your first few seams aren't real straight. It will take time to stitch straight and even. The projects you will make will give you more practice to improve your stitching. Practice, practice, practice!

Go to the "Sewing for Fun" packet and find the directions for the Needle Book. Practice your sewing by following the directions in making a needle book.

When you sew, most seams will be 1/2 inch or 5/8 inch from the edge of the fabric.

When using pins, place them at right angles to the stitching line to hold the fabric in place. Slow down or stop to remove the pins as you come to them.

Practice pinning, practice stitching, practice backstitching and removing the pins as you sew. Remember sewing is a skill and practice makes perfect.

### What Is a Good Seam?

In this project, you will make plain seams. After you finish sewing a seam, see if it meets these standards:

#### ***Machine Stitching:***

- The thread matches or blends with the fabric.
- Is all the same length.
- Looks the same on both sides (balanced tension).
- Starts and finishes at the ends of the seam.
- Is backstitched or knotted at the ends.
- Has thread ends clipped.

#### ***Seam allowances:***

- Are even in width.
- Are flat and smooth.
- Are finished if necessary to prevent raveling.

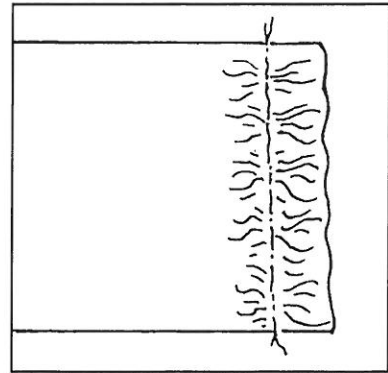

Too Tight

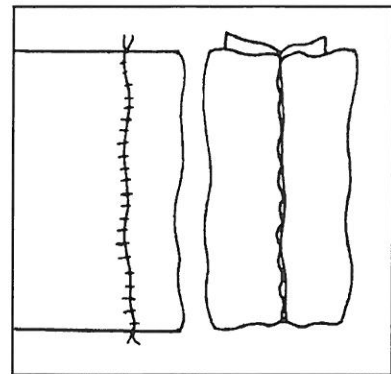

Too Loose

### Sewing License

Ask the person who owns the sewing machine to watch you name its parts and sew using the machine. If you show your knowledge and skill successfully, have the owner and your 4-H leader sign your license. It is in the back of this manual.

### Learning To Measure

Learning to sew also means you need to learn to measure. Practice measuring using your tape measure or a ruler.

Measure the following lines. Write your answer on the top of each line.

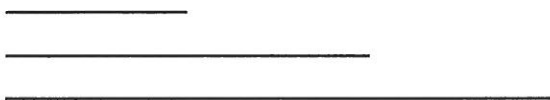

\_\_\_\_\_ Measure these lines to the nearest 1/2 inch.

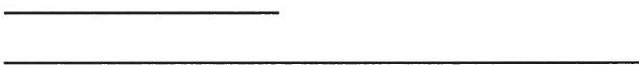

\_\_\_\_\_ Measure these lines to the nearest 1/4 inch.



\_\_\_\_\_ Measure these lines to the nearest 1/8 inch.

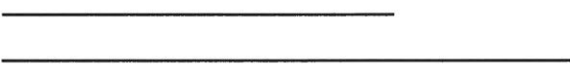

Using your ruler or tape measure draw the following lines below: 4 inches, 3/4 inch, 1/4 inch, 1/2 inch, 5/8 inch and 1 1/2 inches.

Label your measurement. Then ask your leader or parent to check your work.

## Fabric Facts

Fabric fibers are either natural or manmade. Natural fibers are cotton, linen, wool and silk. Cotton and linen come from plants. Wool and silk are animal products. The manmade or synthetic fibers come from chemicals. Polyester and nylon are two examples. Sometimes natural and synthetic fibers are blended together to take advantage of the best qualities of both.

Fabric is made three ways — woven, knitted and felted.

In **woven fabrics** the yarns go over and under one another as shown in the drawing. The interlacing of these two yarns is called weaving.

In **knitted fabrics** the yarns interlock in a series of loops. This is why most knits stretch. Look at your sock or a T-shirt. These are knitted. Your sweaters are knitted, too.

**Felt** is made from a mass of fibers that are matted together. Heat, moisture and pressure are applied to the fibers, making them hold together without being woven. Felt does not have yarn direction or grain and does not ravel.

In each box, place a sample of woven, knitted and felted fabric.

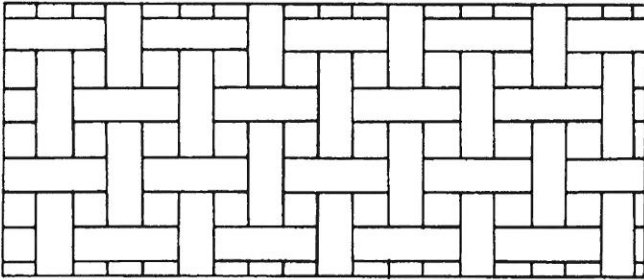

WOVEN

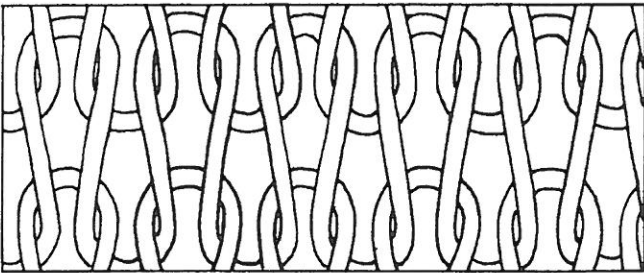

KNITTED

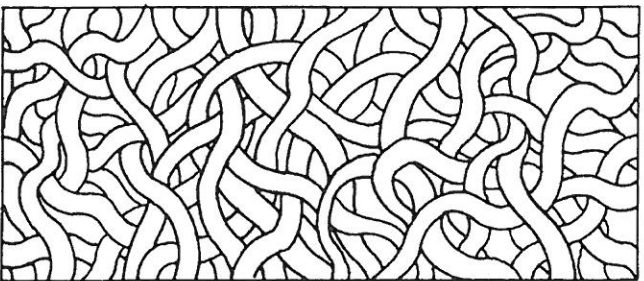

FELT

## Fabric Terms

Here are terms you need to learn. Study and be able to identify them on a bolt of fabric and on the piece of fabric you use for your project.

Woven fabric is made of yarns that go in two directions. These two yarns are lengthwise and crosswise yarns.

**SELVAGE** — The woven lengthwise edge of the cloth. It is closely woven and will not ravel.

**LENGTHWISE YARNS** — Yarns that run the long way of the fabric.

**CROSSWISE YARNS** — Yarns that run crosswise to the selvage.

**ON GRAIN** — The lengthwise and crosswise yarns lie at perfect right angles.

**OFF GRAIN** — The crosswise grain slants from one side of the fabric to the other.

**BIAS** — The diagonal direction of fabric. Yarns do not run in the direction of the bias.

**TRUE BIAS** — It is located by folding the crosswise yarns on top of the lengthwise yarns. True bias has the greatest amount of stretch or give.

**FOLDED EDGE** — Where the fabric is doubled. Most fabric is folded when you buy it.

**RAW EDGE** — Any cut or torn edge of fabric.

**BOLT** — A cardboard form on which fabric is wrapped. Fabric on a bolt is folded in half and is displayed with the right side of fabric out.

**WIDTH OF FABRIC** — The distance across the fabric between selvages. Fabric comes in different widths. A common width is 44 or 45 inches wide.

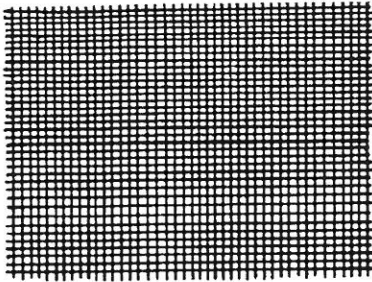

On Grain Fabric

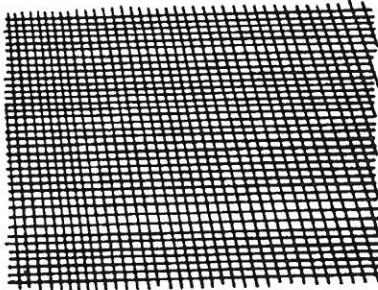

Off Grain Fabric

Do “Fabric Lingo” in back of this manual.

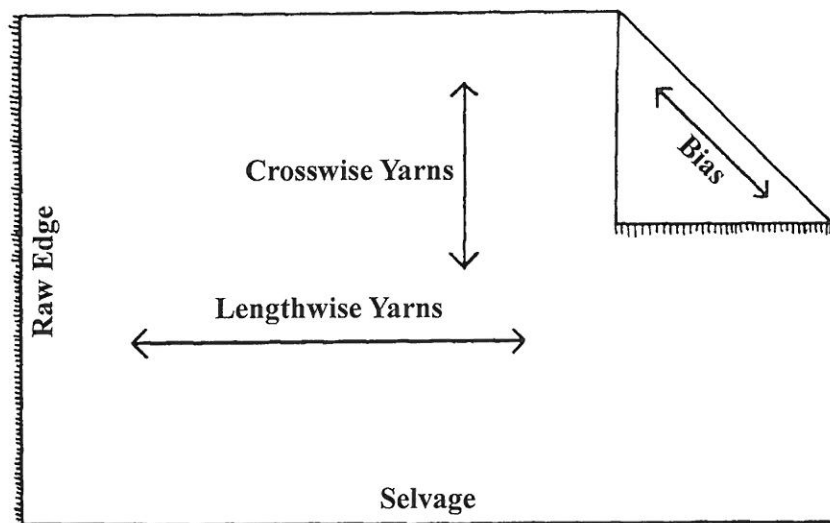

## Grain Perfect Fabric

Woven fabric should be “grain perfect” before you pin and cut on it.

Fabric bought from a store usually has been cut, but is not “grain perfect.” To straighten this type of fabric, follow these steps:

1. Clip the selvage on the shortest edge (as shown).
2. Tear the fabric if it can be torn without damage.
3. If it can't be torn, pull a crosswise thread through the fabric and trim off the uneven edge. Pull the thread very carefully with one hand and at the same time push the fabric back with the other hand. If the thread breaks, that's OK. Cut on the line where the thread was removed, then pick up the end of the broken thread and keep pulling until you get across the selvage. Cut along the space where the thread was removed.
4. Do this to both crosswise edges of your fabric. Ask your 4-H leader or a family member for help.

Check out the entire piece of fabric to be sure the crosswise and lengthwise yarns are at right angles to each other. Do this in the following way:

1. Fold the fabric in half on a table with selvage edges lying on top of each other. If the cut edges do not line up, the fabric is off grain.
2. Straighten it by pulling on the short corners as shown. You are pulling fabric on the bias. Check from time to time to see if you have straightened the fabric. It may be necessary to ask your 4-H leader or a family member to help you straighten your fabric. Wetting your fabric also may help pull it on grain. Now use heat and steam to reset the fibers in the fabric.

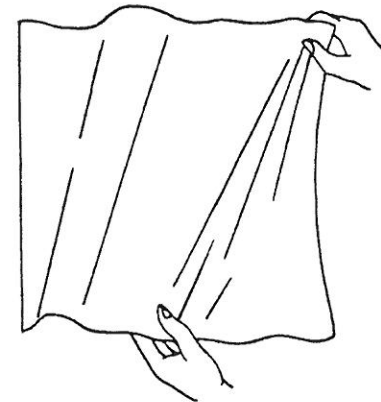
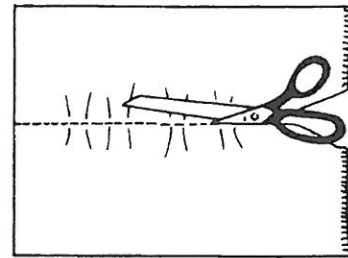
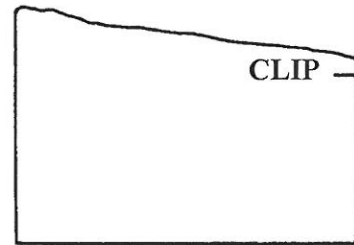

## Choosing Fabrics

Some fabrics are easier to work with than others. Fabrics such as lightweight denim, gingham, chambray, percale and many cotton blends are good choices for beginning sewers. They are of medium weight and firm but not stiff. It will be easier to start with felt and woven fabric first.

Before you choose your fabric, consider the following:

- Print fabric is a good choice. If you make mistakes, they do not show up as much. A print fabric has a right and wrong side.
- Look at the label on the end of the bolt. It will tell you the kind of fiber and the best way to wash it. Write down the information.

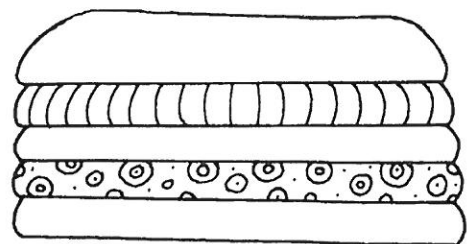

- Preshrink your fabric before cutting and sewing it. Some fabrics shrink the first time they are washed. Also, fabrics may be stiff because too much finish was used. Washing makes them easier to work with. Wash and dry the fabric according to the care label directions.
- Some fabrics wrinkle after they have dried. Press the fabric and remove the centerfold crease. If you cannot remove the crease, avoid it when you cut out your project. Your leader or a family member will show you how to refold the fabric.
- Buy your sewing notions when you buy your fabric. Notions are items like thread, elastic and buttons. It is easier to match thread color when you have your fabric with you.

### Hand Sewing

During this project you will begin to do some hand sewing. Practice threading the needle, tying knots and doing some of the basic stitches. Use **DOUBLE** thread when you are sewing on buttons and a **SINGLE** thread for other hand sewing.

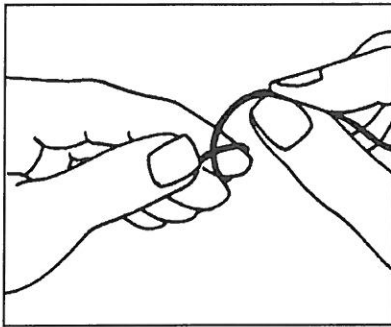

### To Thread a Needle

Use a size 7 or 8 crewel needle. Your thread should be a piece no longer than your arm. Long threads tangle. Cut the thread at a slant. Hold a needle and thread. Bring the thread through the needle.

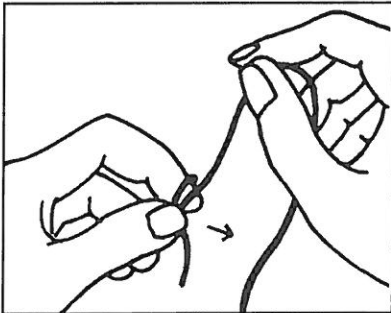

### To Tie a Knot

1. Wrap the end of the thread around the end of your first finger.
2. Tightly roll the cross end into a loop as you push the loop off the end of your finger with your thumb.
3. Pull the loop into a knot with your thumb and middle finger. As you do so, pull the knot down to the end of the thread.

If you find it difficult to make a knot, take two or three small stitches in the fabric to form a knot. If you are left-handed, you will sew with your left hand.

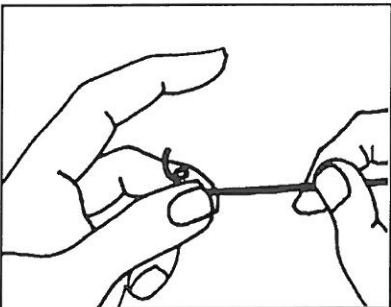

### Sewing By Hand With a Thimble

Put a thimble on your middle finger. Hold the needle between the thumb and first finger. Let the end of the needle rest against the end or the side of the thimble. Push the needle through your fingers with the thimble until you get the “feel” of it.

### Why Should You Use a Thimble?

It seems awkward at first but, with practice, it can be a friend. Using it for all hand sewing will protect your finger and make sewing easier. It will keep the needle from punching your finger when you sew thick fabrics.



## Basic Hand Stitches

The **RUNNING STITCH** is used for basting, easing, gathering and mending where there will be no pull. Take several stitches forward, weaving the needle in and out of the fabric. The size of the stitch depends on the purpose of the stitching — longer stitches for basting or temporary stitching and shorter stitches where sewing will be permanent.

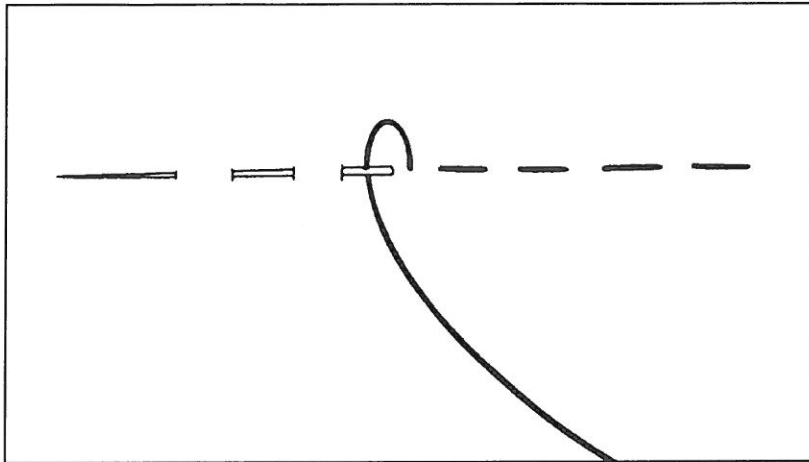

The **SLIP STITCH** is used when you don't want the stitches to show. It might be used for hemming or for closing the opening of a stuffed toy or pillow. Slip the needle through the edge of the fold of the top fabric. Then pick up a thread of the under fabric. Space the stitches evenly — about 1/4 inch apart. Be sure the thread does not show or pull on the right side. Secure the end of your stitches by pulling your needle through the loop of the last stitch before you pull the thread through the fabric. Do this a couple of times to secure the end.

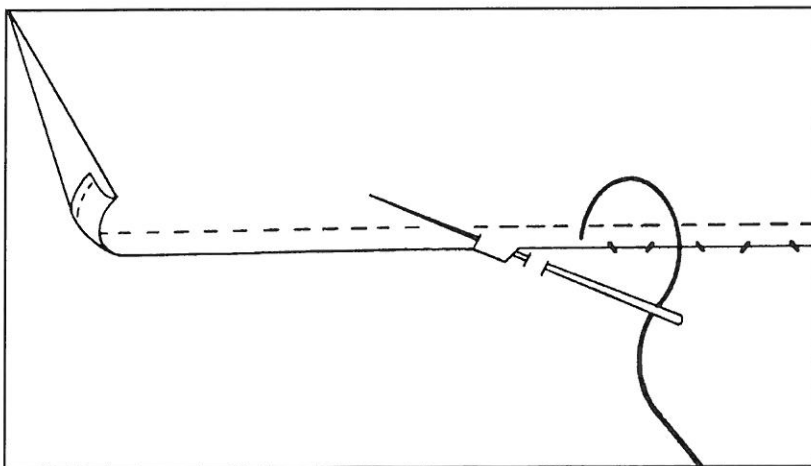

The **OVERHAND** and **WHIP STITCHES** hold two edges together. For the **OVERHAND** stitch, put the needle in at a diagonal through the back and front edges so the stitch itself is straight. For the **WHIP STITCH**, put the needle into the fabric square with the edge so the stitches are slanted. Either stitch can be used to attach lace or trim or to close openings of stuffed toys or pillows. The overhand stitch is less easily seen.

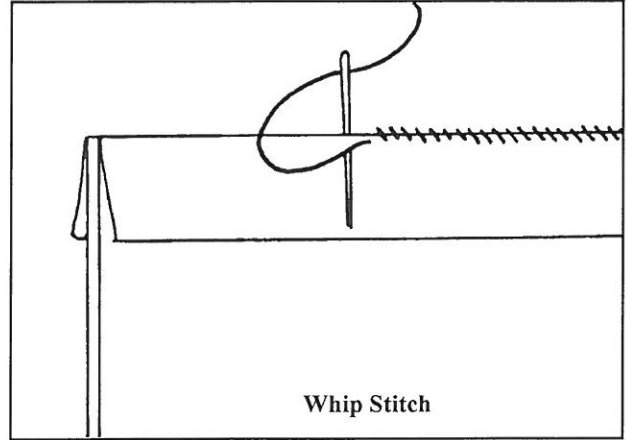
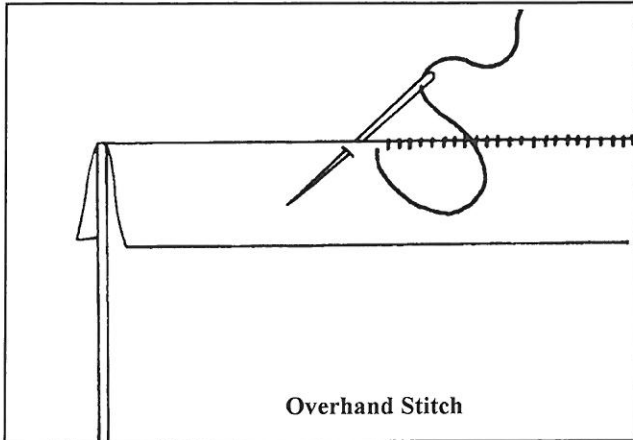

### Pressing

Always press as you sew. This makes the next step easier and helps make the item you made look good. Keep an iron and ironing board set up whenever you sew. Press each seam. Press with the grain of the fabric so you don't stretch it out of shape. Pressing is a lifting and lowering of the iron on the fabric. Don't press over pins as they will scratch the bottom of the iron. Get in the habit now to **PRESS AS YOU SEW**. Sew, press, sew, press, sew, press.

An iron with dry and steam settings is needed for pressing various fabrics. Set the temperature of the iron for the kind of cloth you are pressing. Have an adult family member check the iron setting. Always test the iron temperature first by pressing on a small scrap of the fabric you are sewing. If the iron is too hot, it may melt the fabric, leave marks or make the fabric shiny. Handle the iron carefully. Remember steam is hot and can cause a burn. The owner's booklet will tell you how to use and care for your iron.

Press from the wrong side of your project first, then top press from the right side. Always turn the iron off and unplug it when you are finished using it.

## IT'S SEW TIME

Now that you have learned to run the sewing machine and to sew on fabric, it's time to make something. Many simple items can be made without buying a pattern. After you sew these projects, you will be able to sew something that is a little harder.

You will need the "Sewing For Fun" packet for the directions to make different projects. Each project tells you what supplies you will need and what sewing skills you will learn. Check off each step as you complete it. Be sure to look at the drawings. They will help to put your project together.

Over two to three years, you should make at least six items for yourself or others. The projects range from easy to more difficult. How many more of them you make will depend on your sewing skill. You should be able to check off 40 of the 52 skills listed in the Sewing Skills Check List in the back of this manual at the completion of this project.

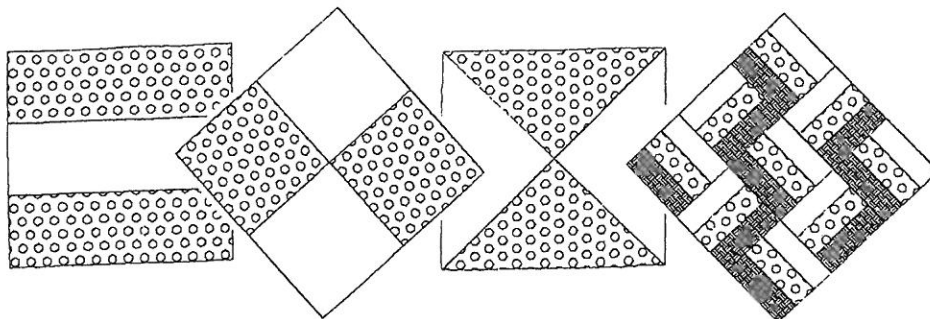
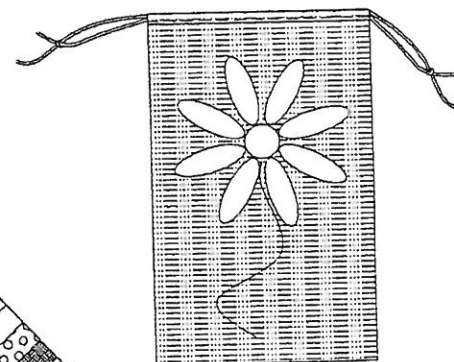
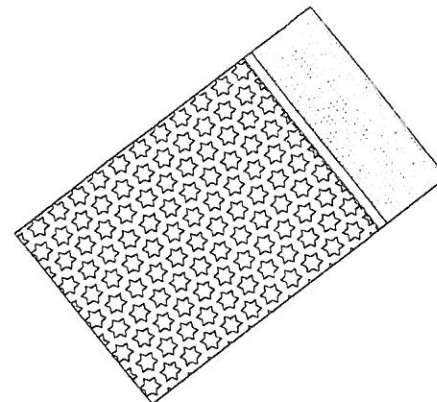
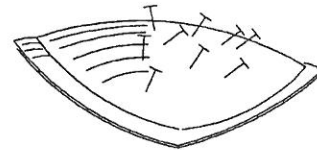

# Sewing Skills Check List

## Sewing for Fun

Be able to check off 40 of the 52 skills listed

### Sewing Tools, identify and use:

- Scissors and shears
- Marking pens
- Pins and pincushion
- Seam ripper
- Thimble
- Glue stick
- Needles
- Point turner
- Measuring tools, ruler, tape, seam gauge

Skills I Know	Skills to Learn or Improve	New Skills Learned

### Sewing Machine, be able to:

- Name parts of machine
- Thread machine
- Fill and insert bobbin
- Recognize good stitching
- Control speed
- Control fabric when stitching
- Regular stitch
- Backstitch
- Baste stitch
- Zigzag stitch (if your machine does this)
- Use seam guide on machine
- Pivot
- Use good habits: bright light, good posture, use wastebasket, put away tools

### Fabric Knowledge, be able to recognize:

- Differences between knit, woven and felt fabric
- Lengthwise grain
- Crosswise grain
- Bias, true bias
- Selvage

Raw edge

Folded edge

Bolt of fabric

### Construction, be able to:

- Pretreat fabric
- Straighten fabric
- Lay out pattern, if using one
- Cut accurately
- Press seams
- Final press

Skills I Know	Skills to Learn or Improve	New Skills Learned

### Machine sewing:

- Sew straight seams
- Sew square corners
- Sew curved seams
- Use plain finish on seams
- Backstitch at the ends
- Trim seams
- Machine hem

### Hand sewing:

- Tie a knot
- Use a thimble
- Running stitch
- Slip stitch
- Overhand stitch or
- Whip stitch

### Additional Skills Learned

---

---

---

---

---

---

---

---

---

---

# *Sewer's License*

This License, with all its privileges and obligations, presented to

\_\_\_\_\_, entitles bearer to operate a sewing machine alone or in the company of others, the aforesaid licensee having duly met the established requirements and having demonstrated a satisfactory understanding of the care and use of a sewing machine.

Authorized by:

Date: \_\_\_\_\_

\_\_\_\_\_ **4-H Leader**

\_\_\_\_\_ **Parent (Guardian)**

American Home Sewing Association, Teacher Service Division, 1270 Broadway, Suite 1007, New York, New York 10001

## Fabric Lingo



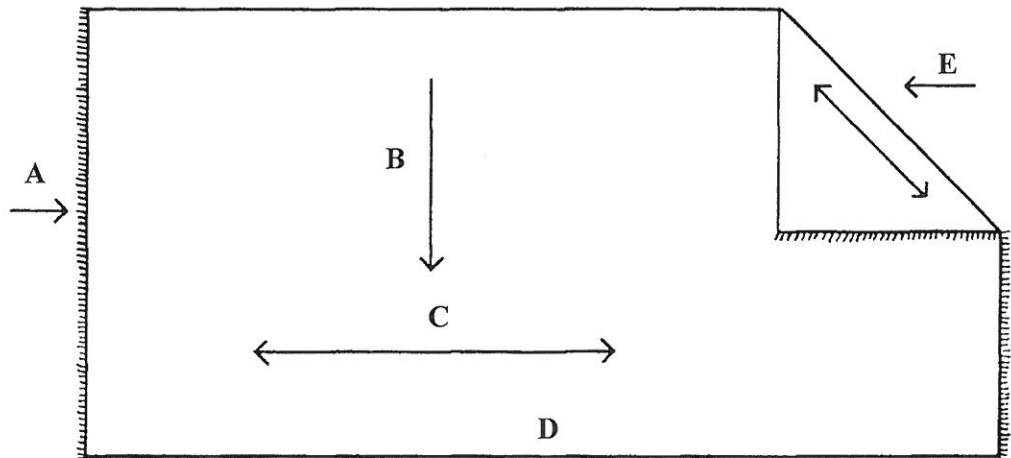





Identify the different parts of woven fabric.

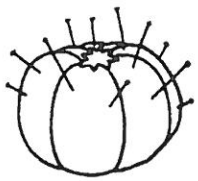

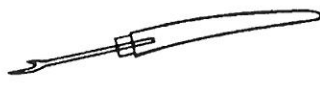
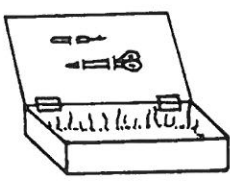
- A. \_\_\_\_\_
- B. \_\_\_\_\_
- C. \_\_\_\_\_
- D. \_\_\_\_\_
- E. \_\_\_\_\_

# Sewing Tools Crossword Puzzle

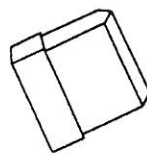
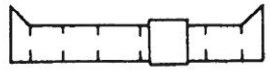
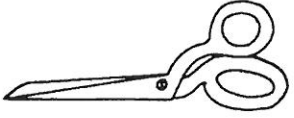
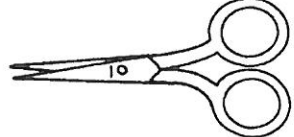
Insert the word that fits the pictures in the crossword below:

<p>Across:</p> <p>3. </p> <p>5. </p> <p>6. </p> <p>7. </p>	<p>9. &amp; 10. </p> <p>12. </p> <p>13. </p> <p>14. </p> <p>15. &amp; 16. </p>	<p>Down:</p> <p>1. </p> <p>2. </p> <p>4. </p> <p>5. &amp; 11. </p>
---	---	--

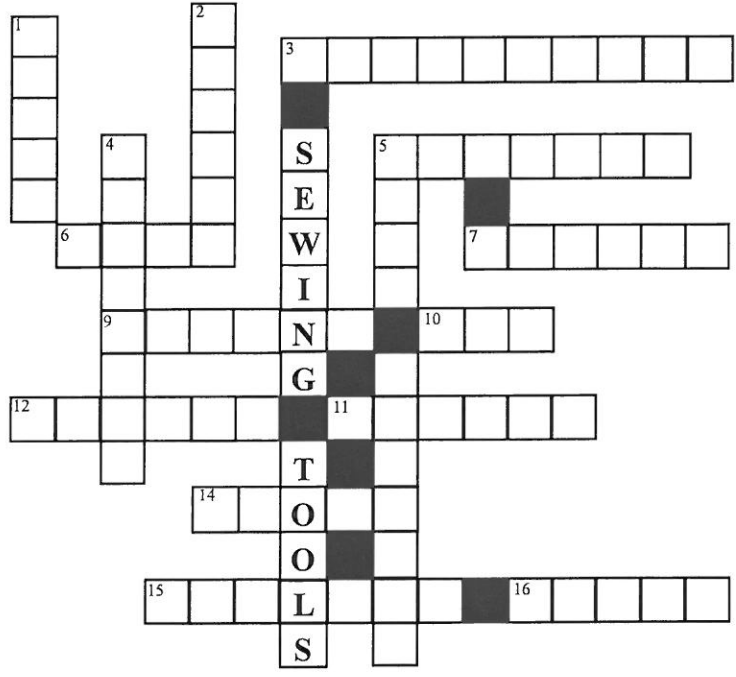

# Sewing Machine Parts Crossword Puzzle

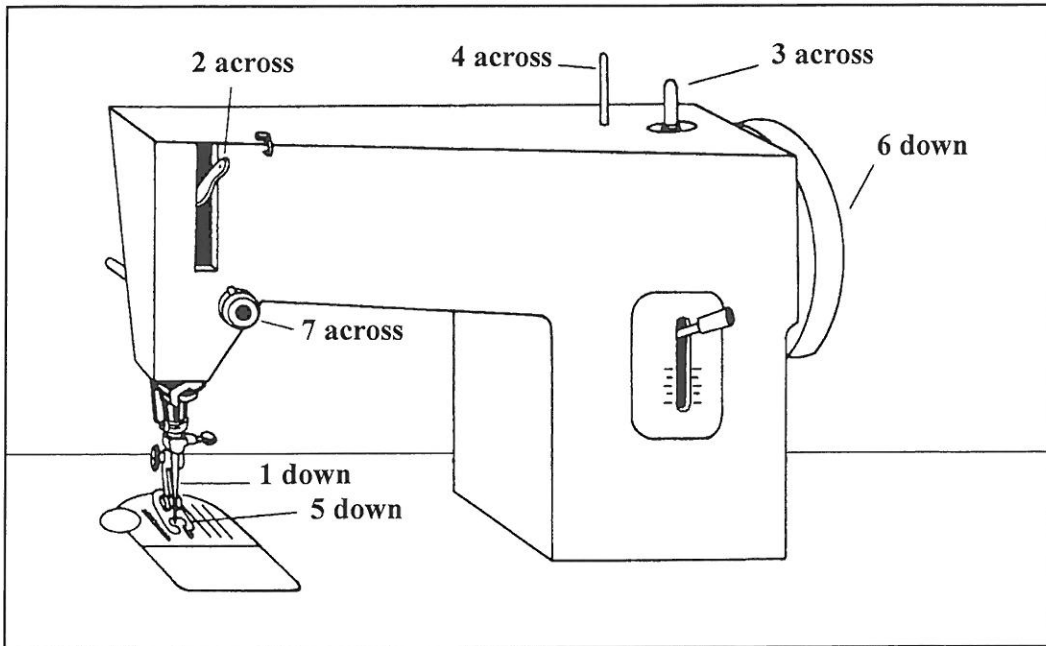

Name the part each number is pointing to on the sewing machine picture and list it in the crossword below:

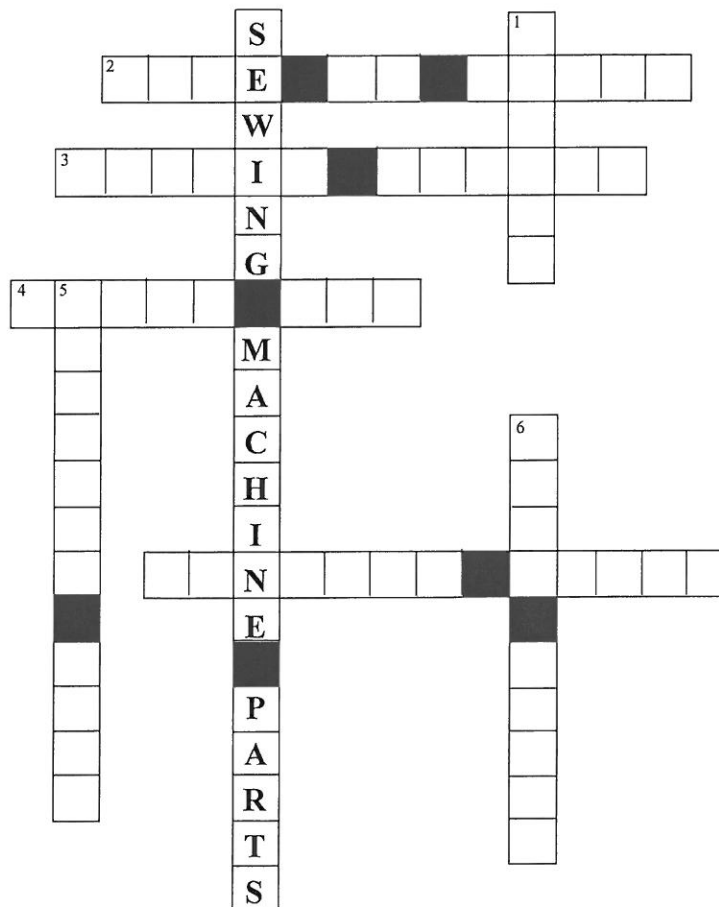

Stitching Chart

